

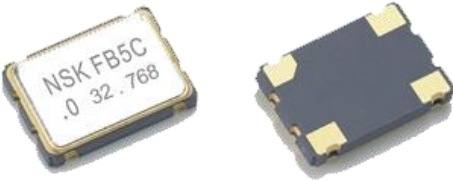











NAOH Series 5.0 x 3.2

  	Application : <ul style="list-style-type: none">  Typically used for real time clock application  Mobile Phone / Set-top Box  Notebook PC / Portable PC  Car navigation systems  Wireless LAN
	Features : <ul style="list-style-type: none">  Meet clock signal for tight tolerance requirement  Tight symmetry (45 to 55%) available  Low Power Consumption  Tri-state enable / disable  Excellent solderability

Electrical Specification :

Model		NAOH-53		
Frequency Range	KHz	32.768		
Oscillation Mode		Fundamental		
Output Type		CMOS		
Output Load	pF	15		
Frequency Stability	PPM	A: ±100 B: ±50 C: ±30 D: ±25		
Operating Temp Range	°C	-20 ~ +70 or specify		
Storage Temp Range	°C	-55 ~ +125		
Power Supply Voltage	VDC	3.3V±10%	2.5V±5%	1.8V±5%
Voltage Vol / Voh	%	10% VDD (Max) / 90% VDD (Min)		
Output Symmetry		40% ~ 60% or 45% ~ 55% (at 55%VDC)		
Tri-state Voltage Vol / Voh		0.3 VDD / 0.7 VDD		
Start Time	mS	10		
Current Consumption	uA	240 (Max)		
Rise and Fall Time	nS	200 (Max)		

* Above specification subject to change without prior notice, please consult our sales representative for more information*

TAIWAN — JENJAAN QUARTEK CORPORATION

Address : 3F-5, No 504 Yun Shan Road, Chung Ho City, Taipei, Taiwan
 Tel : +886-2-8221-4498 Fax : +886-2-8221-4499
 E-mail : jjenjaan@jenjaan.com.tw Web : http://www.nsk.com.tw

FACTORY - DONG GUAN ALLIED PROJECT LIMITED

Address : No. 703, Fu Min Zhong Road, Yang Yong Village, Dalang
 Town, Dong Guan, Guang Dong, China Tel : +86-769-8311-9395
 Fax : +86-769-8313-0880 E-mail : alliedj@pub.dgnet.gd.cn

SMD TYPE CERAMIC OSCILLATORS



Dimensions (mm) :

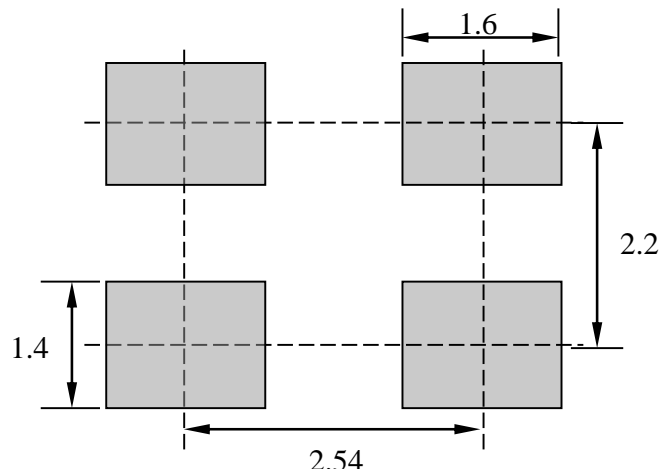
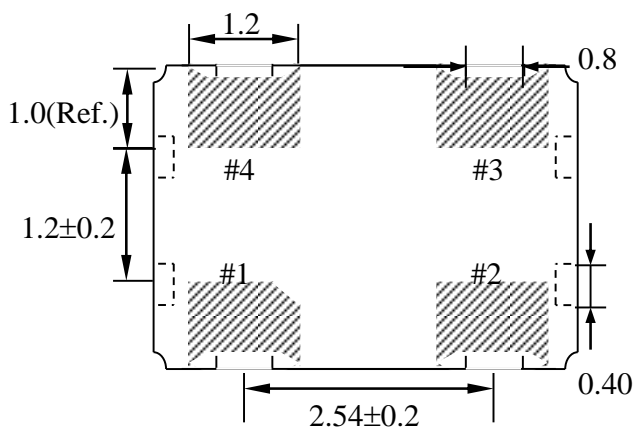
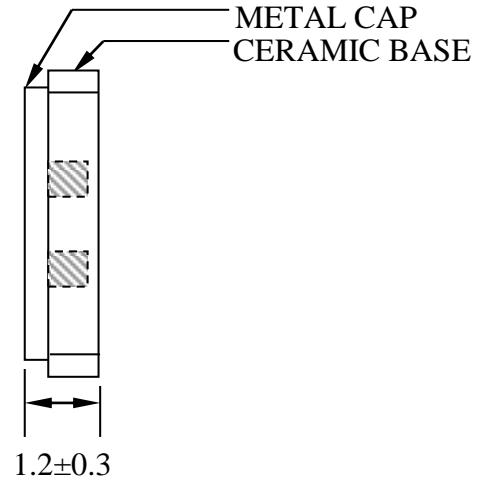
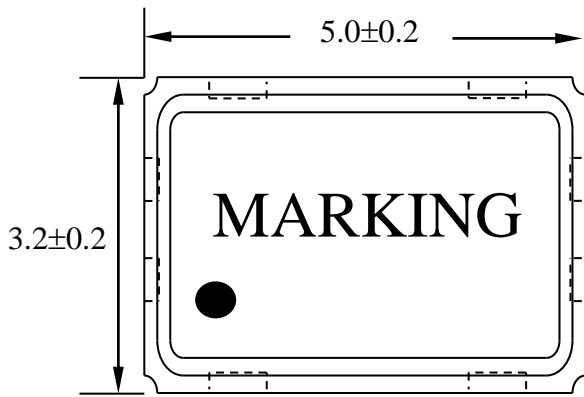

#1: ENABLE / DISABLE FUNCTION

INH (PIN 1)	————→	OUTPUT (PIN 3)	# NO.: define	
High (OPEN)	————→	Operating	#4: VDD	#3: OUTPUT
LOW	————→	High impedance	#1: E/D	#2: GND

* Above specification subject to change without prior notice, please consult our sales representative for more information*

TAIWAN — JENJAAN QUARTEK CORPORATION

Address : 3F-5, No 504 Yun Shan Road, Chung Ho City, Taipei, Taiwan
 Tel : +886-2-8221-4498 Fax : +886-2-8221-4499
 E-mail : jenjaan@jenjaan.com.tw Web : http://www.nsk.com.tw

FACTORY - DONG GUAN ALLIED PROJECT LIMITED

Address : No. 703, Fu Min Zhong Road, Yang Yong Village, Dalang
 Town, Dong Guan, Guang Dong, China Tel : +86-769-8311-9395
 Fax : +86-769-8313-0880 E-mail : alliedj@pub.dgnet.gd.cn

Tape Specification(mm) :

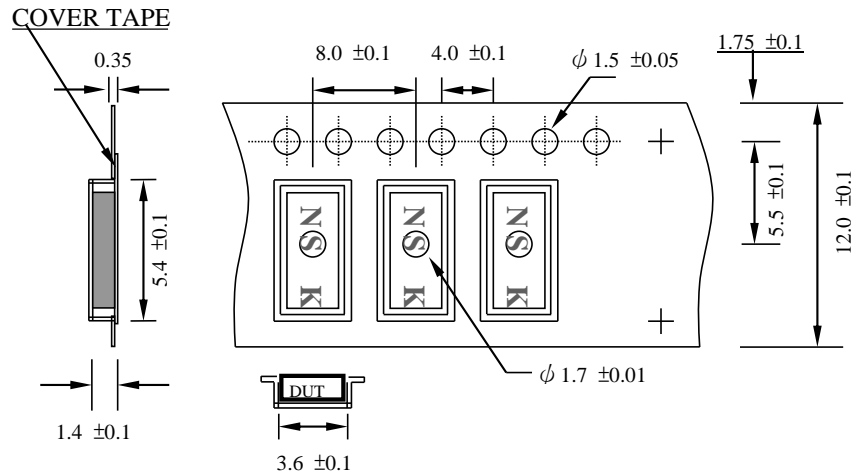

Reel Packing(mm) :

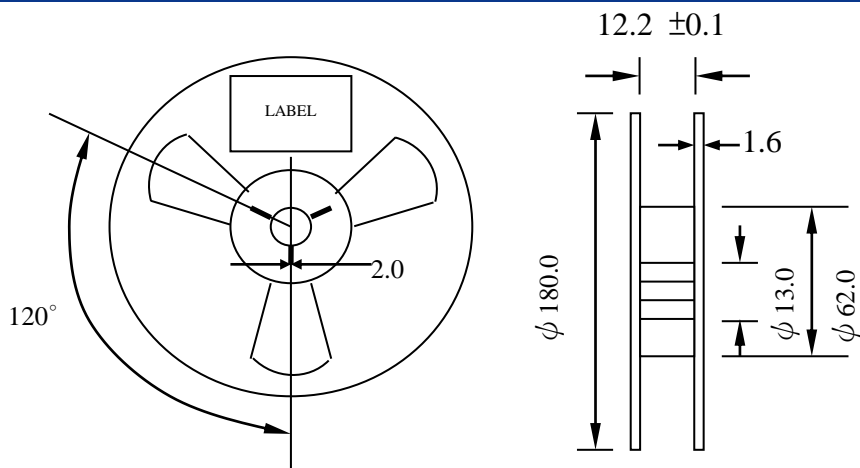

Reflow Temperature Profile :

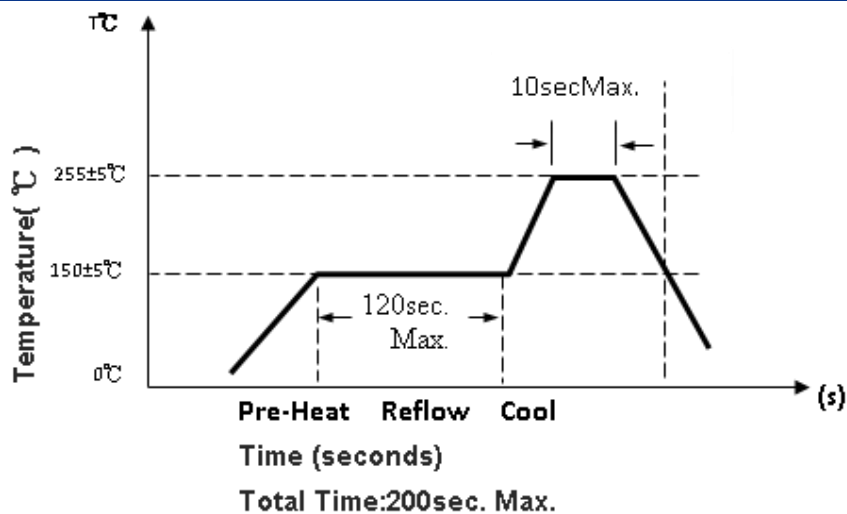

* Above specification subject to change without prior notice, please consult our sales representative for more information*

TAIWAN — JENJAAN QUARTEK CORPORATION

Address : 3F-5, No 504 Yun Shan Road, Chung Ho City, Taipei, Taiwan

Tel : +886-2-8221-4498

E-mail : jenjaan@jenjaan.com.tw

Fax : +886-2-8221-4499

Web : <http://www.nsk.com.tw>

FACTORY - DONG GUAN ALLIED PROJECT LIMITED

Address : No. 703, Fu Min Zhong Road, Yang Yong Village, Dalang

Town, Dong Guan, Guang Dong, China Tel : +86-769-8311-9395

Fax : +86-769-8313-0880

E-mail : alliedj@pub.dgnet.gd.cn