













NAPD Series 7.0 x 5.0

   	Application : <ul style="list-style-type: none">  XDSL / SONET / SDH  Wideband WLAN AP  1G /10G Ethernet  Fiber Channel
	Features : <ul style="list-style-type: none">  Low phase jitter (12KHz to 20MHz) under 1 ps (RMS)  Low profile package design (1.9mm height max.)  Tri-state function available  Differential output

Electrical Specification :

Model		NAPD-75
1. Frequency		
Frequency Range	MHz	25.0 ~ 200.0
Frequency Stability	PPM	A: ±100 B: ±50 C: ±30 D: ±25
2. Temperature Range		
Operating Temp Range	°C	-10 ~ +70, -40 ~ +85 or specify
Storage Temp Range	°C	-55 ~ +125
Output Voltage High (V _{OH})	V (Min.)	1.025 VDD
Output Voltage Low (V _{OL})	V (Max.)	1.625 VDD
Output Load	Ω	50
Output Symmetry	%	45% ~ 55%
3. Input Voltage		
Enable High Input Voltage	V (Min.)	0.7 VDD
Enable Low Input Voltage	V (Max.)	0.3 VDD
Current	mA (Max.)	80
Rise / Fall Time (20% / 80%)	nS (Max.)	1.0
Aging	PPM / Year	±3
Start Up Time	mS (Max.)	10

* Above specification subject to change without prior notice, please consult our sales representative for more information*

TAIWAN — JENJAAN QUARTEK CORPORATION

Address : 3F-5, No 504 Yun Shan Road, Chung Ho City, Taipei, Taiwan
 Tel : +886-2-8221-4498 Fax : +886-2-8221-4499
 E-mail : jjenjaan@jenjaan.com.tw Web : http://www.nsk.com.tw

FACTORY - DONG GUAN ALLIED PROJECT LIMITED

Address : No. 703, Fu Min Zhong Road, Yang Yong Village, Dalang
 Town, Dong Guan, Guang Dong, China Tel : +86-769-8311-9395
 Fax : +86-769-8313-0880 E-mail : alliedj@pub.dgnet.gd.cn



Dimensions (mm) :

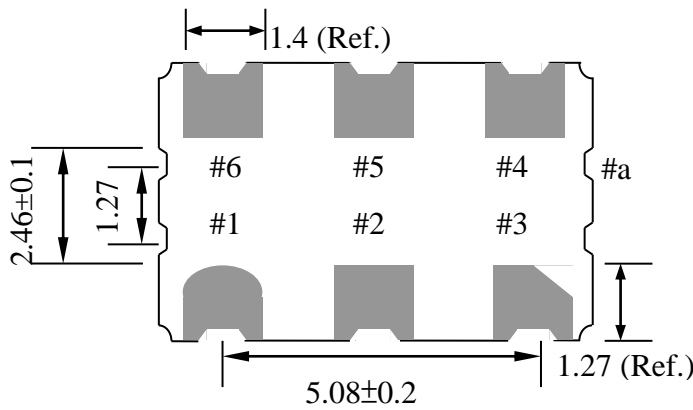
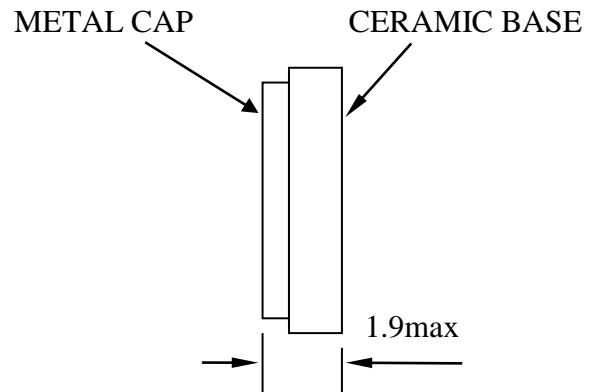
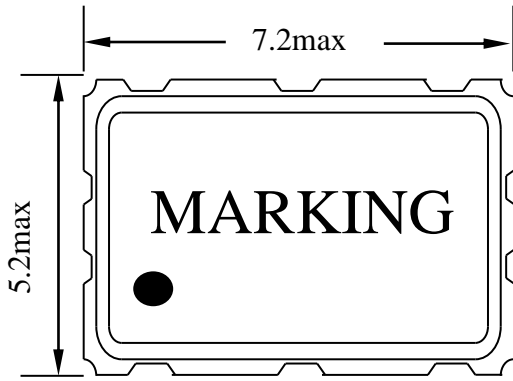

< TOP VIEW >

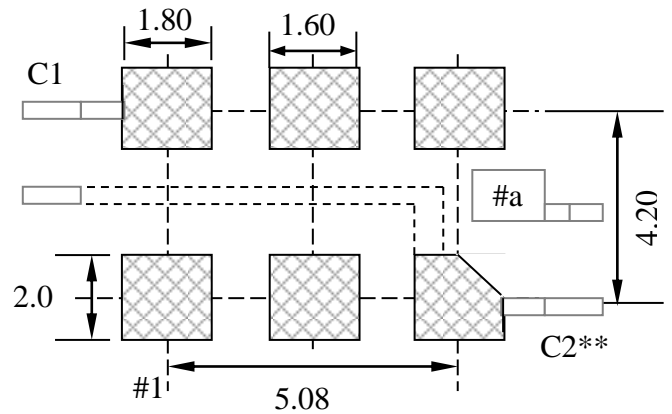

(Recommended Land Pattern)

# NO.: Pin define		
#6: Vcc	#5: QN	#4: Q
#1: E/D	#2: NC	#3: GND

* Above specification subject to change without prior notice, please consult our sales representative for more information*

TAIWAN — JENJAAN QUARTEK CORPORATION

Address : 3F-5, No 504 Yun Shan Road, Chung Ho City, Taipei, Taiwan
 Tel : +886-2-8221-4498 Fax : +886-2-8221-4499
 E-mail : jenjaan@jenjaan.com.tw Web : http://www.nsk.com.tw

FACTORY - DONG GUAN ALLIED PROJECT LIMITED

Address : No. 703, Fu Min Zhong Road, Yang Yong Village, Dalang
 Town, Dong Guan, Guang Dong, China Tel : +86-769-8311-9395
 Fax : +86-769-8313-0880 E-mail : alliedj@pub.dgnet.gd.cn

