

NX2016SA For OA / AV/ Short-range Wireless

■ Features

A small and thin surface-mount type crystal unit, especially suited for small-sizing requirements.

- Ultra compact and thin. (2.0 × 1.6 × 0.45 mm)
- Excellent environmental characteristics, including heat and shock resistance.
- Excellent electrical performance, ideal for OA (office automation), AV(audiovisual), Bluetooth and Wireless LAN applications.
- Lead-free. Meets the requirements for re-flow profiling using lead-free solder.

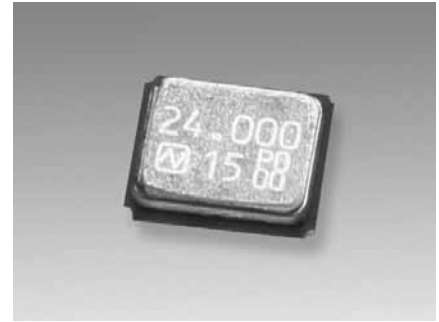

Pb Free

RoHS Compliant
Directive 2011/65/EU

■ Specifications

Item	Model	NX2016SA	
Nominal Frequency		16 to 80 MHz	
Overtone Order		Fundamental	
Frequency Tolerance (25 ±3 °C)		±15 × 10 ⁻⁶	
Frequency versus Temperature Characteristics (with reference to +25 °C)		±25 × 10 ⁻⁶	±15 × 10 ⁻⁶
Operating Temperature Range		-40 to +85 °C	-10 to +75 °C
Storage Temperature Range		-40 to +85 °C	
Equivalent Series Resistance		Refer to *1	
Level of Drive		10 μW (Max. 200 μW)	
Load Capacitance		8 pF	
Specifications Number		STD-CZS-2	STD-CZS-1

■ Dimensions

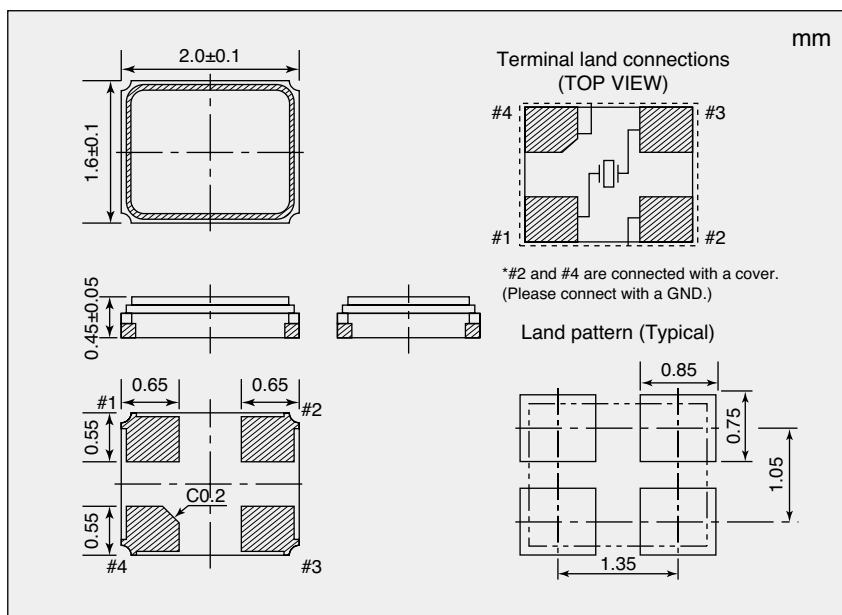

*1 Equivalent Series Resistance

Nominal frequency (MHz)	Equivalent Series Resistance max. [Ω]
16 to 18	200
18 to 20	150
20 to 24	100
24 to 26	80
26 to 40	60
40 to 80	50

Please specify the model name, frequency, and specification number when you order products.
For further questions regarding specifications, please feel free to contact us.