

SPECIFICATION OF SURFACE MOUNT TYPE

1 .TYPE	DSX321SH			
2 .NOMINAL FREQUENCY	12.000000	MHz		
3 .LOAD CAPACITANCE(CL)	12.0	pF		
4 .DRIVE LEVEL	10	μW	+/- 2	μW
5 .FREQUENCY TOLERANCE	+/- 10	$\times 10^{-6}$	at 25 deg.C	+/- 3 deg.C
6 .SERIES RESISTANCE	80	ohms	max. /	CL = SERIES
7 .FREQUENCY CHARACTERISTICS OVER TEMPERATURE(ref. +25 deg.C)	+/- 20	$\times 10^{-6}$	/ -40 deg.C to	+85 deg.C
8 .OPERATING TEMPERATURE RANGE	-40	deg.C	to	+85 deg.C
9 .STORAGE TEMPERATURE RANGE	-40	deg.C	to	+85 deg.C
10 .SHUNT CAPACITANCE(C0)	2.0	pF	max.	
11 .INSULATION RESISTANCE	500 Mohms min. at 100V DC			
12 .OVERTONE ORDER	Fundamental			
13 .DIMENSIONS	Refer to Fig-1			

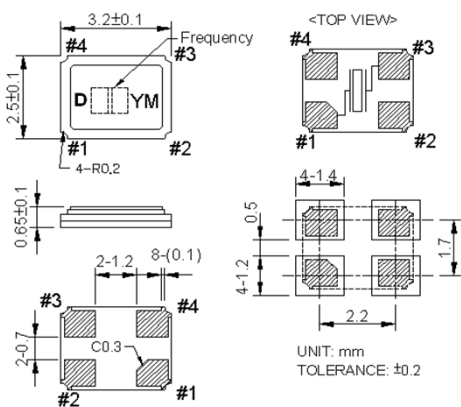

*Marking should be printed as following:
 Logo, Nominal Frequency, Manufactured year & month
 *Nominal frequency = Mark two digits from upper
 (ex. 12.000000MHz --> 12)
 *Manufacturing Lot No.
 (Y : year) ex. 2016 shall be marked as ' 6 ' (The last digit of the year)
 (M : month) ex. March shall be marked as ' C ' (As shown in Table-1.)

(Table-1.)

Month	Jan.	Feb.	Mar.	Apr.	May.	Jun.	Jul.	Aug.	Sep.	Oct.	Nov.	Dec.
Mark	A	B	C	D	E	F	G	H	J	K	L	M

Fig.1